

# HCX 50 T4 (A0:6) Zone 2: FAN (Ex h IIB T3 Gc) + MOTOR (Ex ec IIC T3 Gc)

## GENERAL DATA



SHORT CASE AXIAL ATEX FAN

MANUFACTURING FEATURES:

- Axial fan short casing with circular reinforced frame.
- Motor-impeller assembly through modular system.
- Cast aluminium impeller.
- Polyester powder coat finishing.
- Motor ATEX asíncrono normalizado. Certificado según zona indicada, IP55 protection and class F insulation. Manufactured with standard voltages: 230/400V 50Hz for three phase motors up to 4kW and 400/690V 50Hz for higher powers.

APPLICATIONS

Designed for wall or duct installation, they are suitable for:

- Air renewal in buildings and industries.
- Ventilation in indoor environments classified as ATEX
- Smoke extraction (max 40°C).
- Working temperature: ambient from -20°C to 40°C

UNDER REQUEST

- B form or 100% reversible impeller.
- 60Hz fans and special voltages.

ORGANISM: L.O.M.

CERTIFICAT Nº: LOM 17.755X-C

In compliance with the Directive 2014/34/UE

## PERFORMANCE CURVE

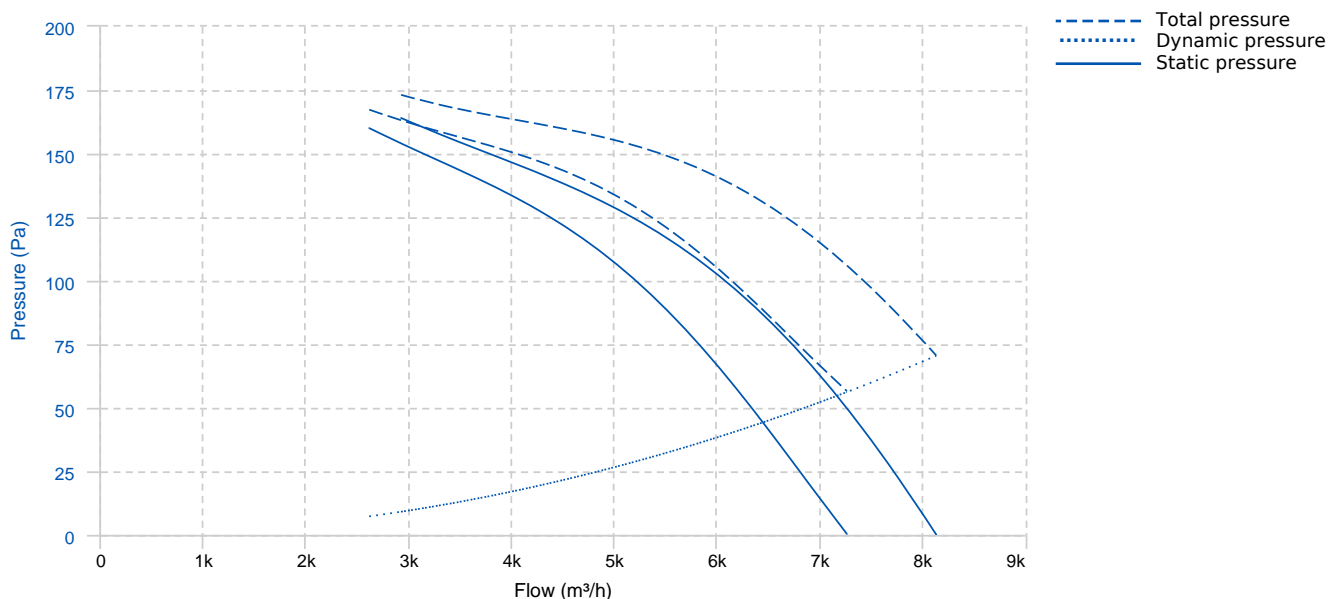

## TECHNICAL DATA

### Fan

RPM	-	Approx. weight	-	Max. Flow	8140 m <sup>3</sup> /h
-----	---	----------------	---	-----------	------------------------

## DIMENSIONS

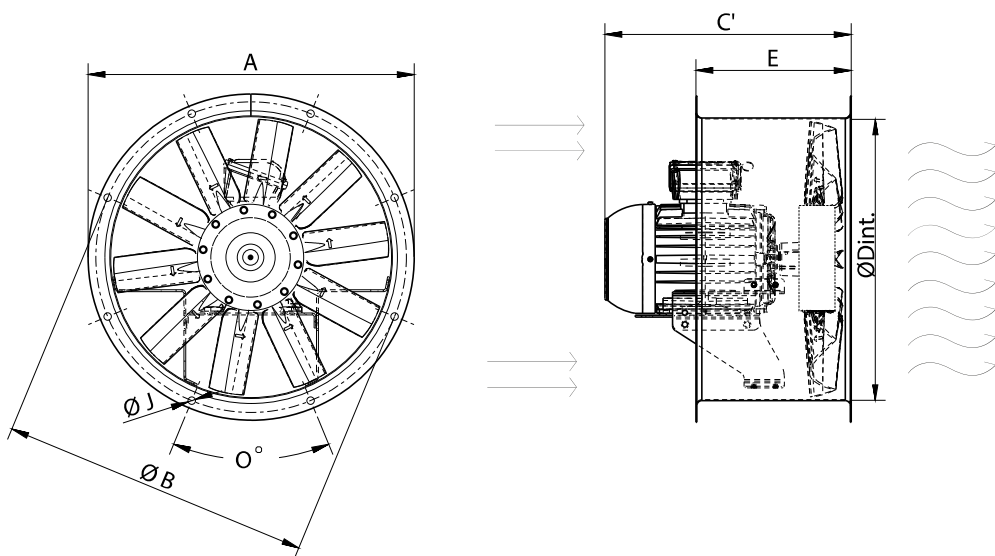

### Dimensions (mm)

C' (Mot.T.71)	348	C' (Mot.T.80)	360	C' (Mot.T.90L)	397	C' (Mot.T.90S)	372	C' (Mot.T.100L)	428
E	250	Ø	12x30°	ØA	600	ØB	560	ØD	504
ØJ	12								

## WIRING DIAGRAM

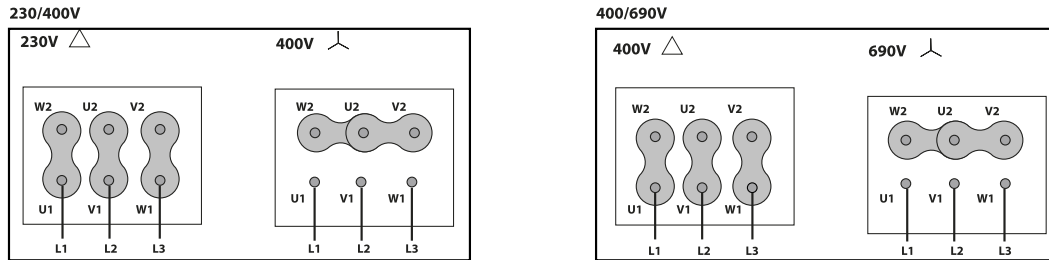

## ACCESSORIES



**PROTECTION GUARD FOR LONG CASE FANS  
RP 50**  
REF: 960320100



**CONNECTION FLANGE  
AC 500**  
REF: 960003214



**ANTI-VIBRATION JOINT  
JE 45**  
REF: A-300719201

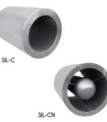

**CIRCULAR SILENCER  
SIL-C 500/750**  
REF: 960050075

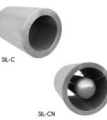

**CIRCULAR SILENCER  
SIL-CN 500/500**  
REF: 961050050

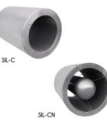

**CIRCULAR SILENCER  
SIL-CN 500/1000**  
REF: 961050100



**FREQUENCY SPEED CONTROLLER  
SFC (GENERIC)**



**CASE FANS MOUNTING SUPPORT  
PO 50**  
REF: 960001656



**ANTI-VIBRATING FLANGE 400ø/2H  
BA-400 50**  
REF: 960002064



**CIRCULAR SILENCER  
SIL-C 500/500**  
REF: 960050050



**CIRCULAR SILENCER  
SIL-C 500/1000**  
REF: 960050100



**CIRCULAR SILENCER  
SIL-CN 500/750**  
REF: 961050075



**CIRCULAR-CIRCULAR ANTI-VIBRATION FLANGE  
BAD 21 (Ø1250)**  
REF: 960003471



**ANTI-VIBRATION RUBBER BLOCK  
AVR (GENERIC)**



**ANTI-VIBRATION SPRING BLOCK  
AVS (GENERIC)**



**ATEX SWITCH  
INT ATEX (GENERIC)**



**INLET PROTECTION GUARD FOR AXIAL FANS  
RP1 (GENERIC)**

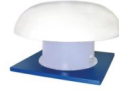

**ROOF KIT FOR CASE FANS  
KIT TE 50  
REF: KTE50**



**METALLIC ROOF KIT FOR CASE FANS  
KIT TM 50  
REF: KTM50**