

# HCX 63 T4 (A5:6) Zone 2: FAN (Ex h IIB T3 Gc) + MOTOR (Ex ec IIC T3 Gc)

## GENERAL DATA

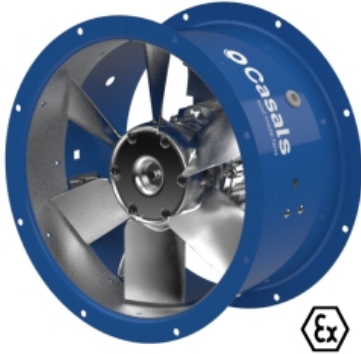

SHORT CASE AXIAL ATEX FAN

MANUFACTURING FEATURES:

- Axial fan short casing with circular reinforced frame.
- Motor-impeller assembly through modular system.
- Cast aluminium impeller.
- Polyester powder coat finishing.
- Motor ATEX asíncrono normalizado. Certificado según zona indicada, IP55 protection and class F insulation. Manufactured with standard voltages: 230/400V 50Hz for three phase motors up to 4kW and 400/690V 50Hz for higher powers.

APPLICATIONS

Designed for wall or duct installation, they are suitable for:

- Air renewal in buildings and industries.
- Ventilation in indoor environments classified as ATEX
- Smoke extraction (max 40°C).
- Working temperature: ambient from -20°C to 40°C

UNDER REQUEST

- B form or 100% reversible impeller.
- 60Hz fans and special voltages.

ORGANISM: L.O.M.

CERTIFICAT Nº: LOM 17.755X-C

In compliance with the Directive 2014/34/UE

## PERFORMANCE CURVE

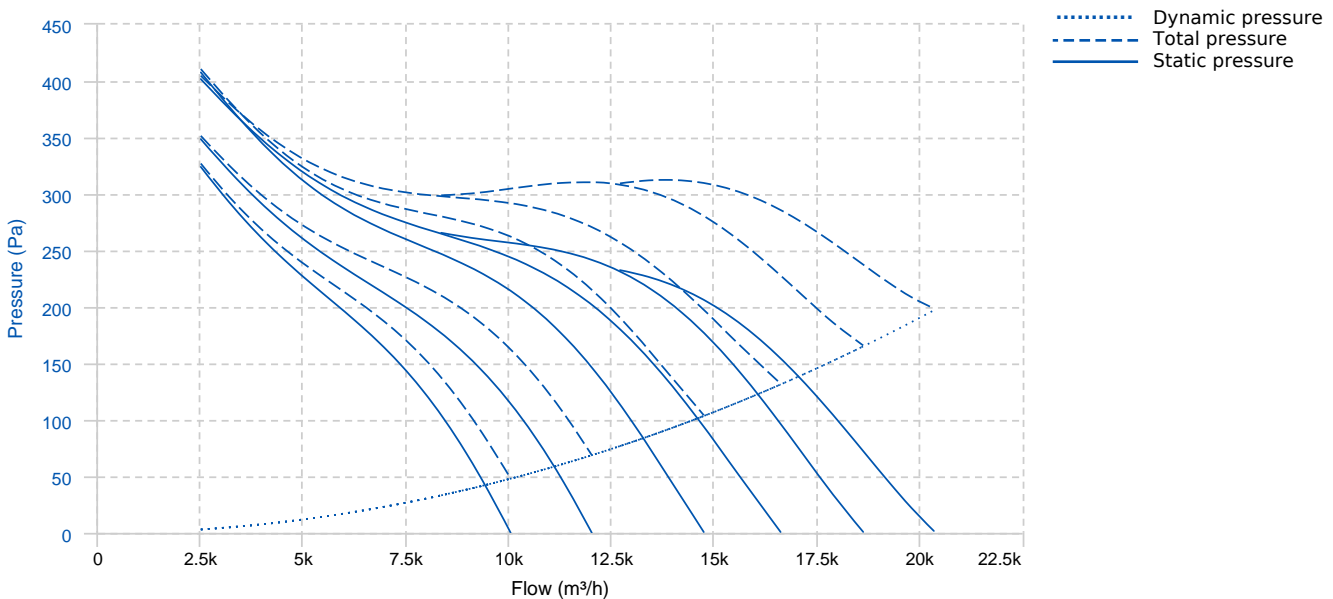

## TECHNICAL DATA

### Fan

RPM	-	Approx. weight	-	Max. Flow	20350 m <sup>3</sup> /h
-----	---	----------------	---	-----------	-------------------------

## DIMENSIONS

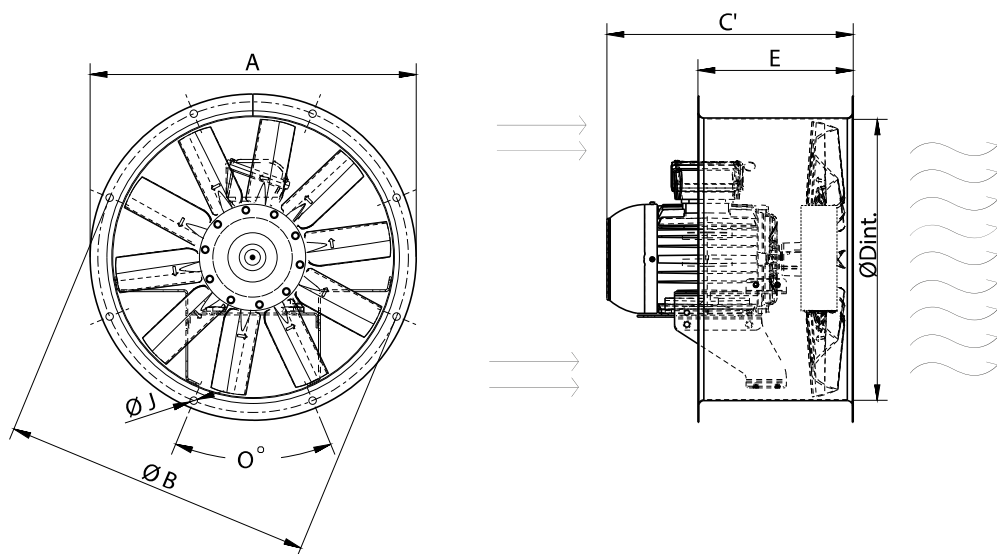

### Dimensions (mm)

C' (Mot.T.80)	359	C' (Mot.T.90L)	398	C' (Mot.T.90S)	393	C' (Mot.T.100L)	450	C' (Mot.T.112M)	471
E	250	O	12X30°	ØA	725	ØB	690	ØD	633
ØJ	12								

## WIRING DIAGRAM

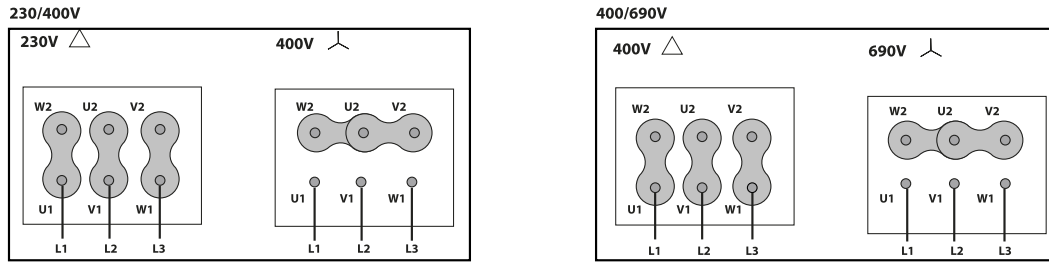

## ACCESSORIES



**PROTECTION GUARD FOR LONG CASE FANS**  
**RP 63**  
 REF: 960330101



**CONNECTION FLANGE**  
**AC 630**  
 REF: 960003216



**ANTI-VIBRATION JOINT**  
**JE 45**  
 REF: A-300719201

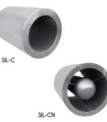

**CIRCULAR SILENCER**  
**SIL-C 630/945**  
 REF: 960063945

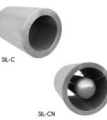

**CIRCULAR SILENCER**  
**SIL-CN 630/630**  
 REF: 961063063

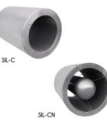

**CIRCULAR SILENCER**  
**SIL-CN 630/1260**  
 REF: 961063126

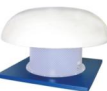

**ROOF KIT FOR CASE FANS**  
**KIT TE 63**  
 REF: KTE63



**CASE FANS MOUNTING SUPPORT**  
**PO 63**  
 REF: 960001658



**ANTI-VIBRATING FLANGE 400º/2H**  
**BA-400 63**  
 REF: 960002057



**CIRCULAR SILENCER**  
**SIL-C 630/630**  
 REF: 960063063



**CIRCULAR SILENCER**  
**SIL-C 630/1260**  
 REF: 960063126



**CIRCULAR SILENCER**  
**SIL-CN 630/945**  
 REF: 961063945



**CIRCULAR-CIRCULAR ANTI-VIBRATION FLANGE**  
**BAD 15 (Ø630)**  
 REF: 960003465



**METALLIC ROOF KIT FOR CASE FANS**  
**KIT TM 63**  
 REF: KTM63



**FREQUENCY SPEED CONTROLLER  
SFC (GENERIC)**



**ANTI-VIBRATION RUBBER BLOCK  
AVR (GENERIC)**



**ANTI-VIBRATION SPRING BLOCK  
AVS (GENERIC)**



**ATEX SWITCH  
INT ATEX (GENERIC)**



**INLET PROTECTION GUARD FOR AXIAL FANS  
RP1 (GENERIC)**