

JFC CORE 315/H T2 UN CONFORT (274310188ST)

GENERAL DATA



LONG CASE CONFORT AXIAL FAN

MANUFACTURING FEATURES:

- Long case axial fan with reinforced body.
- Modular motor-impeller assembly. Polyamide impeller with variable pitch angle. Polyester powder finishing coat.
- Housing with motor access door for easy connection.
- Standard asynchronous squirrel-cage motor with IP-55 protection and Class F. Manufactured with standard voltages: 230/400V 50Hz) for 1 speed motors and 400V 50Hz for 2 speed motors.

APPLICATIONS:

Designed for inline installation, they are suitable for:

- Smoke emergency exhaust with motor inside the hazardous area.
- Maximum working temperature: 60°C.

UNDER REQUEST:

- Supply impeller (air direction from impeller to motor).
- 100% reversible impeller.
- Cast aluminium impeller

PERFORMANCE CURVE

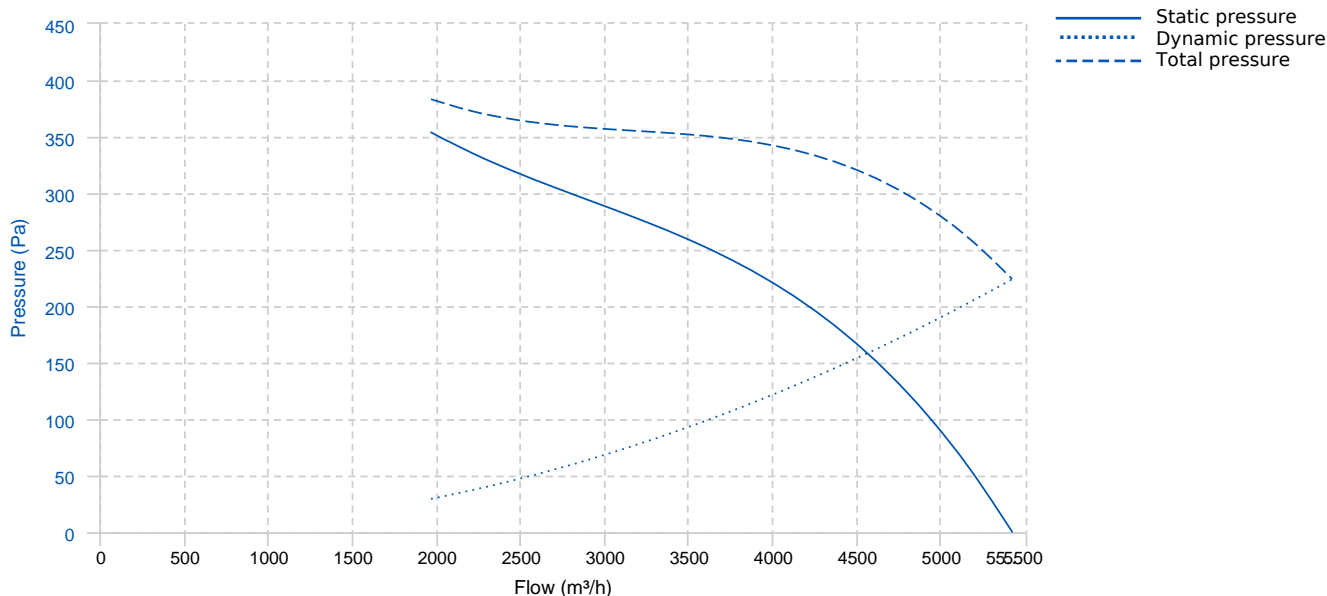

TECHNICAL DATA

Fan							
RPM	2860	Approx. weight	25 kg	Max. Flow	5420 m³/h		
Motor							
Power	1,1 kW	RPM	2860	I max. (400V)	2,39 A	Size	80

Motor

Approx. weight	14 kg	Efficiency (%)	80.5 %	FP	0.85
----------------	-------	----------------	--------	----	------

DIMENSIONS

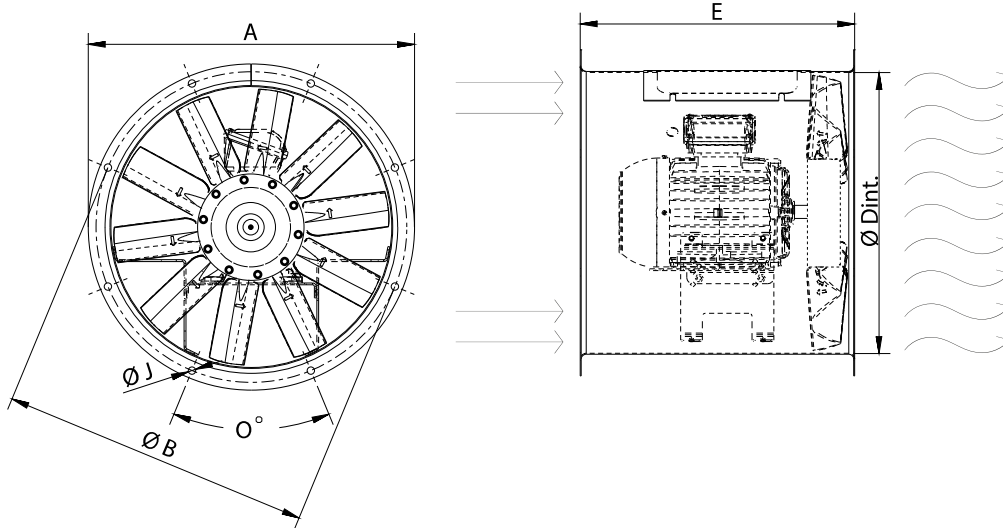

Dimensions (mm)

A	374	E	380	J	10	O	8x45°	ØB	355
ØD	306								

WIRING DIAGRAM

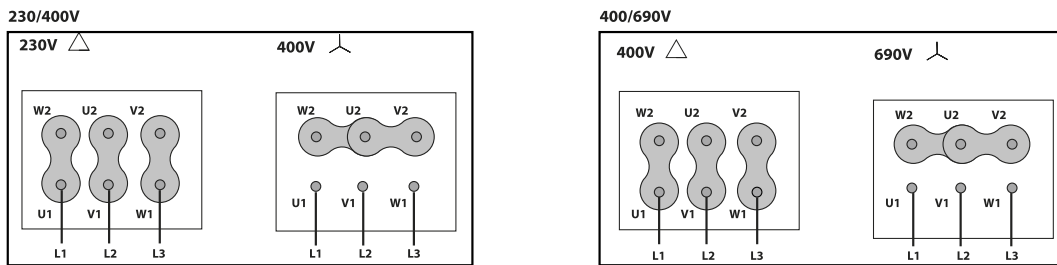



ACCESSORIES



**CEILING ANTI-VIBRATION SPRING BLOCK
AVT (GENERIC)**